

Haar Transform

Averages and differences

- two neighboring samples

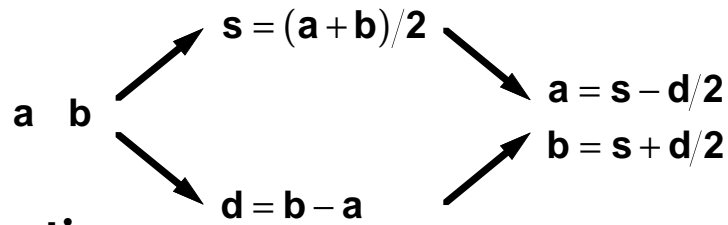

Properties

- exploits correlation
 - better encoding possible
-

Haar Transform

Box function and Haar wavelet

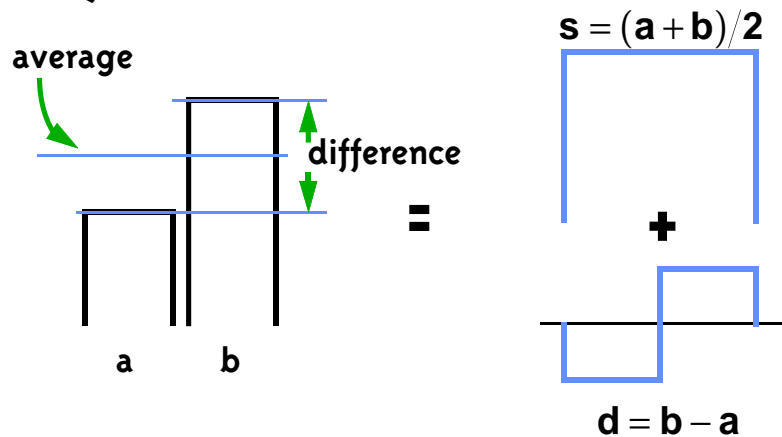

Haar Transform

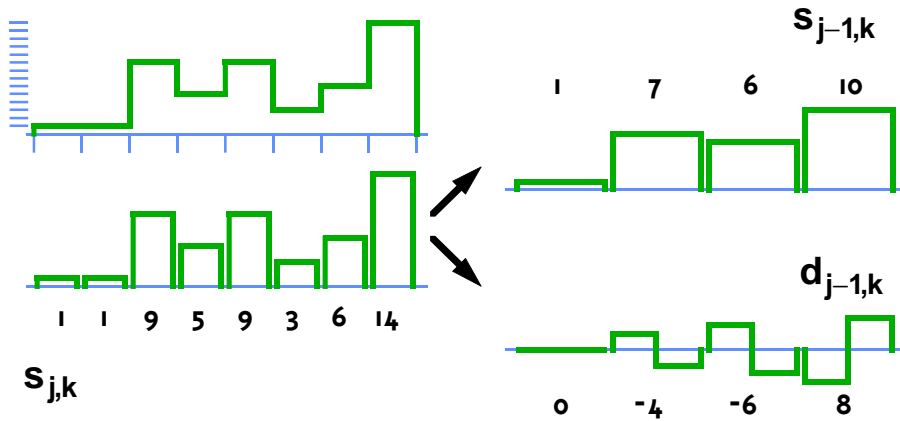

General Structure

Single level step and its inverse

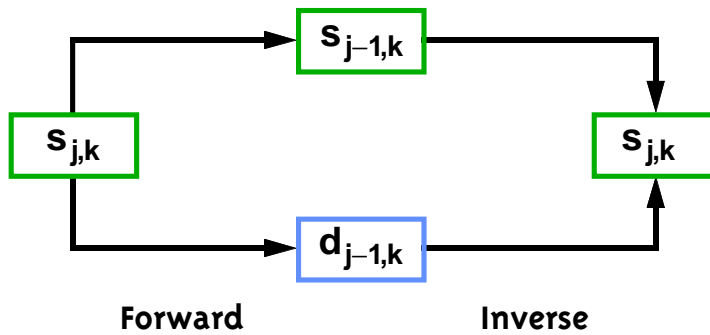

Haar Transform

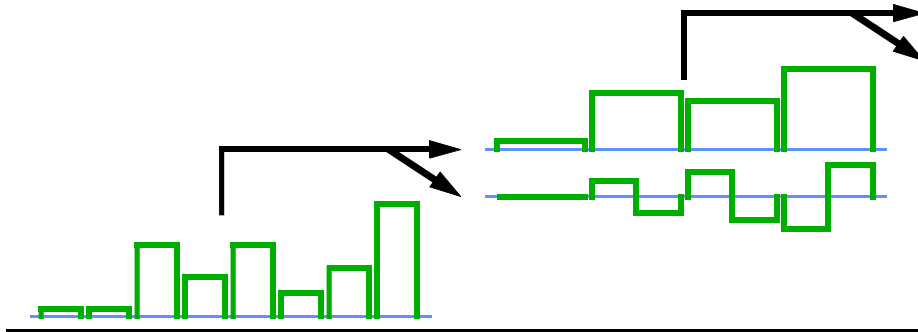

5

Haar Transform

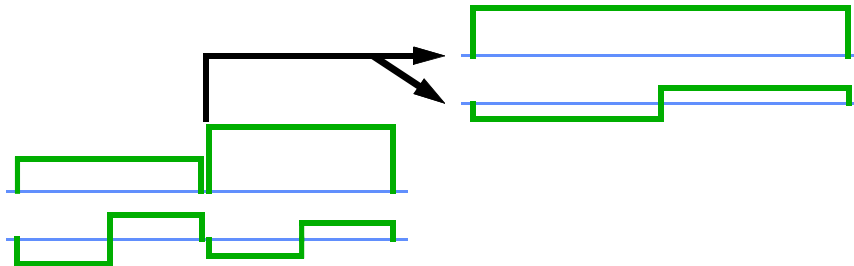

6

Haar Transform

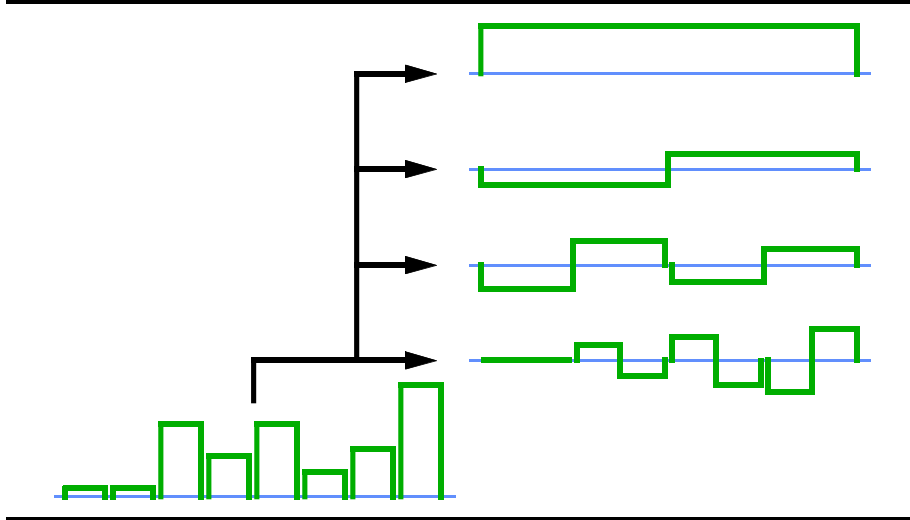

Haar Transform

Pyramid transform

- pass from samples to averages and differences
- linear time: $2n + n + n/2 + n/4 + n/8 + \dots = 4n$
- easy to invert

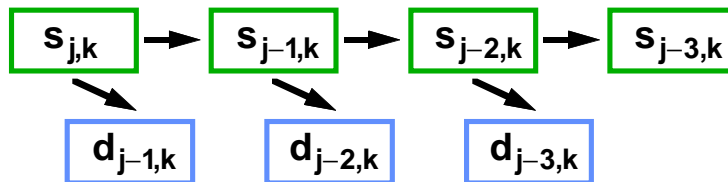

Haar Basis

Change of Basis

- Box basis to Haar basis

- Scaling functions:

$$\varphi_{j,k}(x) = \varphi(2^j x - k)$$

- Wavelets:

$$\psi_{j,k}(x) = \psi(2^j x - k)$$

9

Haar Basis

Change of Basis

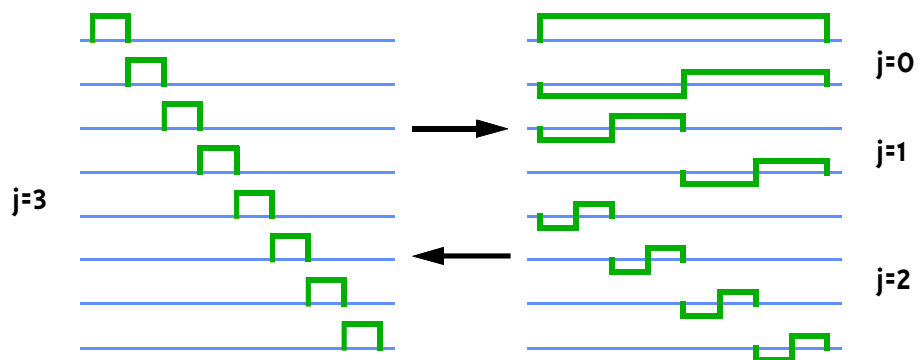

10

Transforming the Image

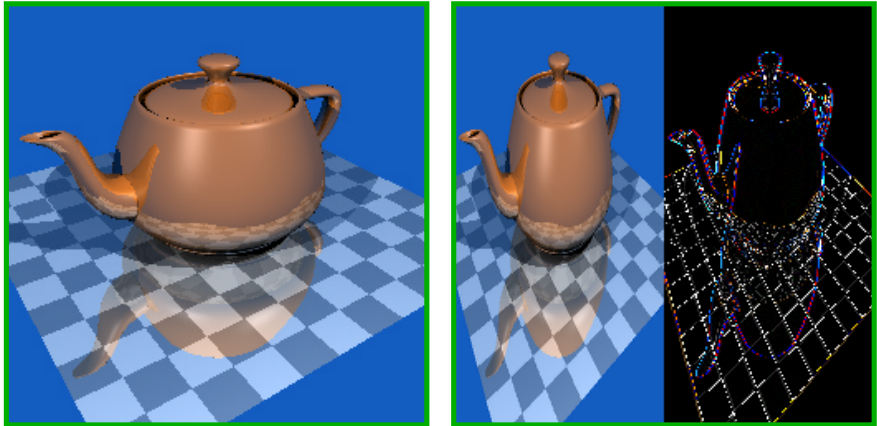

Transforming the Image

